



MT3402 Plastic-Encapsulate MOSFETS

FEATURE

- High dense cell design for extremely low $R_{DS(ON)}$
- Exceptional on-resistance and maximum DC current capability

MARKING: 3402

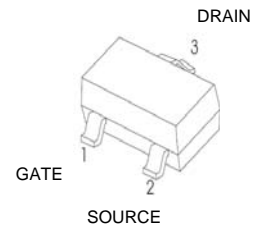
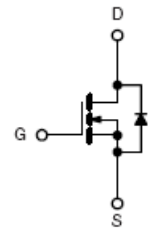

SOT-23

Maximum ratings ($T_a=25^{\circ}\text{C}$ unless otherwise noted)

Parameter	Symbol	Value	Unit
Drain-Source Voltage	V_{DS}	30	V
Gate-Source Voltage	V_{GS}	± 12	V
Continuous Drain Current	I_D	4	A
Pulsed Drain Current (note 1)	I_{DM}	15	A
Power Dissipation	P_D	0.35	W
Thermal Resistance from Junction to Ambient (note 2)	$R_{\theta JA}$	357	$^{\circ}\text{C}/\text{W}$
Junction Temperature	T_J	150	$^{\circ}\text{C}$
Storage Temperature	T_{STG}	-55~+150	$^{\circ}\text{C}$



Electrical characteristics ($T_a=25^{\circ}\text{C}$ unless otherwise noted)

Parameter	Symbol	Test Condition	Min	Typ	Max	Unit
STATIC CHARACTERISTICS						
Drain-source breakdown voltage	$V_{(BR)DSS}$	$V_{GS} = 0V, I_D = 250\mu A$	30			V
Zero gate voltage drain current	I_{DSS}	$V_{DS} = 24V, V_{GS} = 0V$			1	μA
Gate-body leakage current	I_{GSS}	$V_{GS} = \pm 12V, V_{DS} = 0V$			100	nA
Gate threshold voltage (note 3)	$V_{GS(th)}$	$V_{DS} = V_{GS}, I_D = 250\mu A$	0.6	1	1.4	V
Drain-source on-resistance (note 3)	$R_{DS(on)}$	$V_{GS} = 10V, I_D = 4A$		45	55	m Ω
		$V_{GS} = 4.5V, I_D = 3A$		55	70	m Ω
		$V_{GS} = 2.5V, I_D = 2A$		83	110	m Ω
Forward transconductance (note 3)	g_{FS}	$V_{DS} = 15V, I_D = 4A$		8		S
Diode forward voltage (note 3)	V_{SD}	$I_S = 1A, V_{GS} = 0V$		0.8	1	V
DYNAMIC CHARACTERISTICS (note 4)						
Input capacitance	C_{iss}	$V_{DS} = 15V, V_{GS} = 0V, f = 1MHz$		390		pF
Output capacitance	C_{oss}			54.5		pF
Reverse transfer capacitance	C_{rss}			41		Pf
Gate resistance	R_g	$V_{DS} = 0V, V_{GS} = 0V, f = 1MHz$		3		Ω
SWITCHING CHARACTERISTICS (note 4)						
Turn-on delay time	$t_{d(on)}$	$V_{GS} = 10V, V_{DS} = 15V,$ $R_L = 3.75\Omega, R_{GEN} = 6\Omega$		3.3		ns
Turn-on rise time	t_r			1		ns
Turn-off delay time	$t_{d(off)}$			21.7		ns
Turn-off fall time	t_f			2.1		ns
Total gate charge	Q_g	$V_{DS} = 15V, V_{GS} = 4.5V, I_D = 4A$		4.34		nC
Gate-source Charge	Q_{gs}			0.6		nC
Gate-drain Charge	Q_{gd}			1.38		nC
Body diode reverse recovery time	t_r	$I_F = 4A, dI/dt = 100A/\mu s$		1.2		ns
Body diode reverse recovery charge	Q_{rr}			6.3		nC

Notes :

1. Repetitive rating : Pulse width limited by junction temperature.
2. Surface mounted on FR4 board , $t_s \leq 10s$.
3. Pulse Test : Pulse Width $\leq 80\mu s$, Duty Cycle $\leq 0.5\%$.
4. Guaranteed by design, not subject to producing.



Typical Characteristics

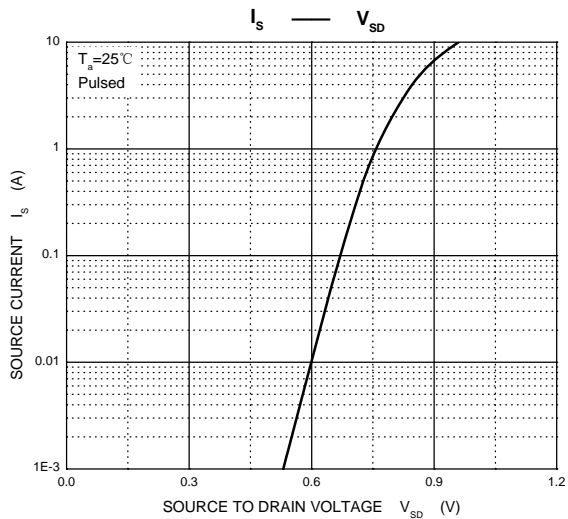
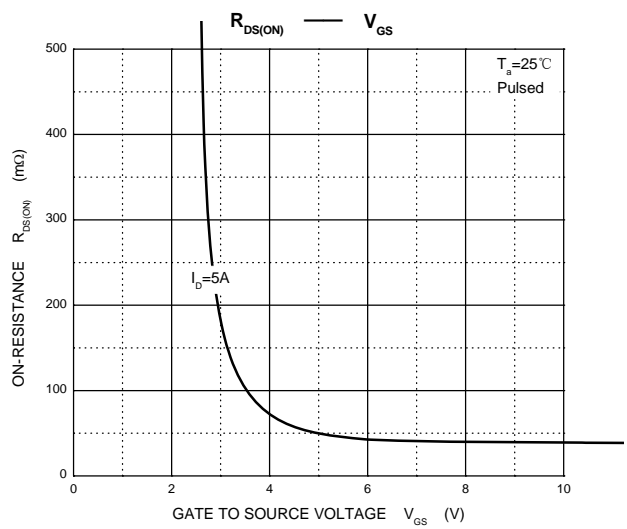
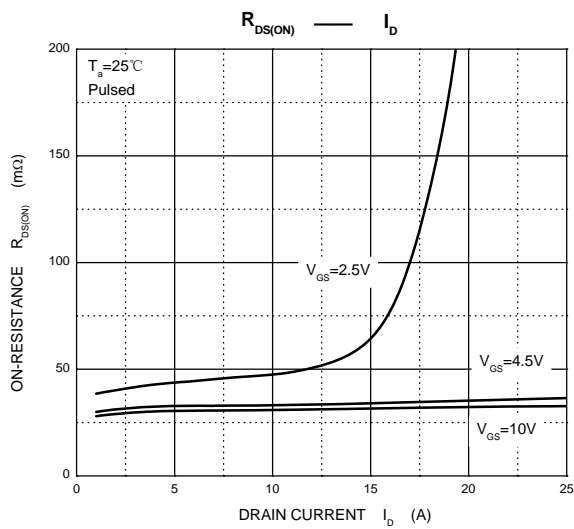
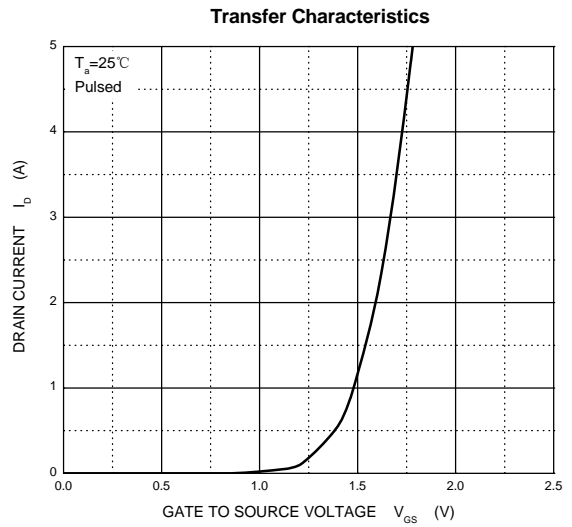
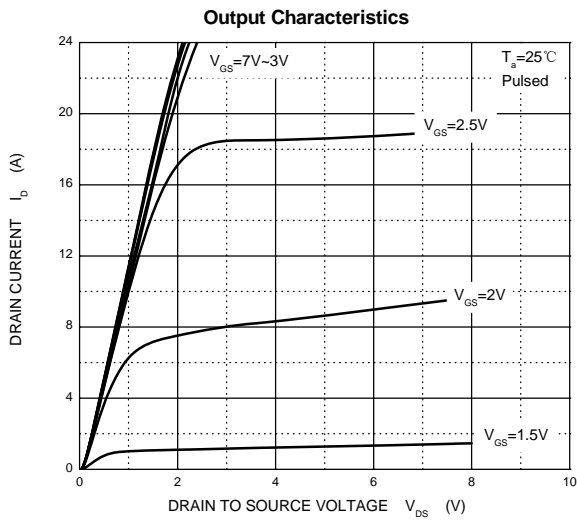



PACKAGE OUTLINE

Plastic surface mounted package; 3 leads

SOT-23

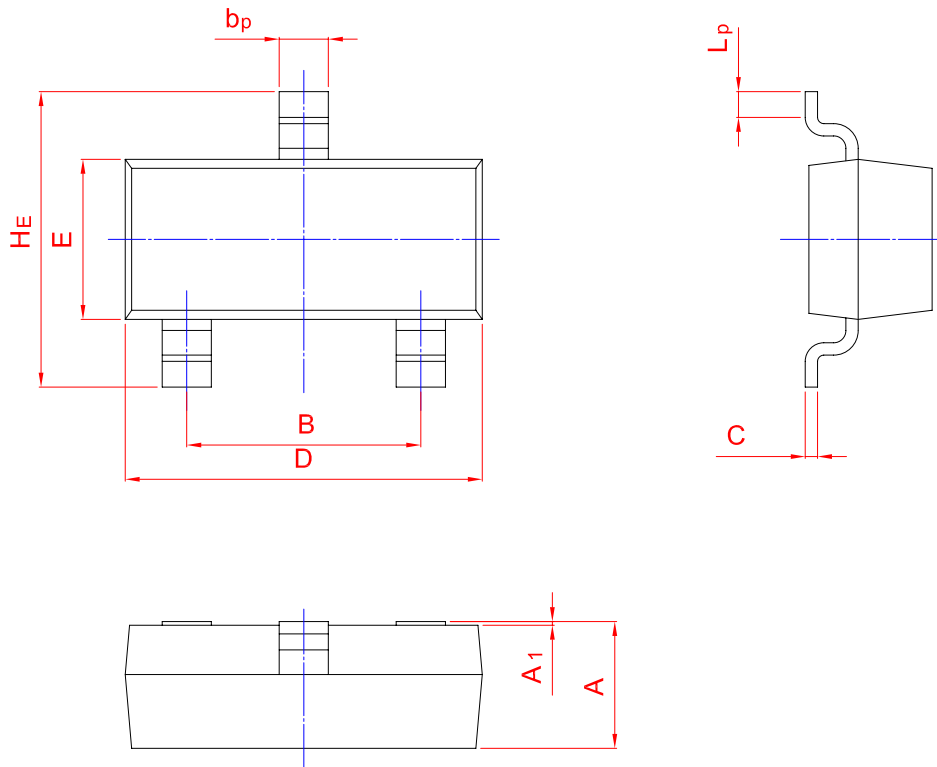
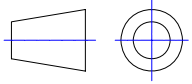

UNIT	A	B	bp	C	D	E	HE	A1	Lp
mm	1.40	2.04	0.50	0.19	3.10	1.65	3.00	0.100	0.50
	0.95	1.78	0.35	0.08	2.70	1.20	2.20	0.013	0.20